

CWDM-8E-1xxx-1xxx

8 and 16 Channel CWDM Filter/Mux with Express port for Video and Data applications

Data Sheet

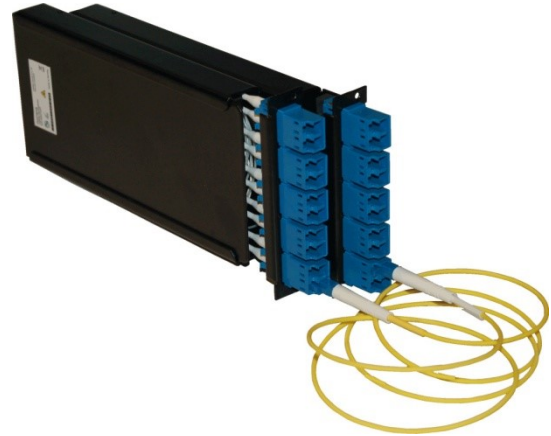

Description

The CWDM-8E-1xxx-1xxx are passive CWDM MUX/DMUX filters that fit with the miniHUB frame.

Each CWDM filter has 10 ports, 8 ports for accepting the CWDM wavelengths and a common port that combines the 8 channels for feeding to and from your fiber network. These filters also have an EXPRESS port which allows these units to be cascaded into a larger 16 channel CWDM system.

These filters use the LC/PC fiber connectors that are preferred by SMPTE

With two of these filters you can obtain a 16 channel CWDM system in a 1 rack unit miniHUB frame, that's compact.

These filters are shipped in pairs of one MUX and one DMUX.

Part Number Options

Part Number	Channel wavelengths (nm)	Temperature *)
CWDM-8E-1270-1410	1270 ~ 1410	0°C to +40°C
CWDM-8E-1470-1610	1470 ~ 1610	0°C to +40°C

*) Rated temperature for the complete miniHUB.

Features

- Up to 16 channels per fiber
- Easy upgrade from 8 to 16 channels
- Express port can be used for +1 channel communication (1310nm or 1550nm)
- Compliant to SMPTE 297-2006
- Compliant to ITU-T G.694.2
- High isolation allowing bi-directional traffic
- LC/UPC connector

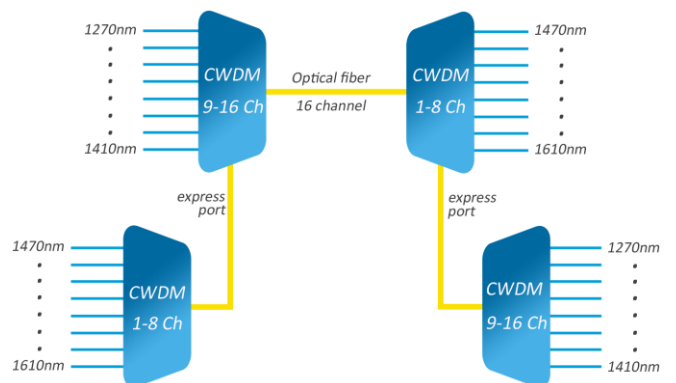

Absolute Maximum Ratings

Absolute maximum ratings are those values beyond which functional performance is not intended, device reliability is not implied, and damage to the device may occur.

Parameter	Minimum	Maximum	Unit
Storage temperature (non-operating)	-40	+85	°C
Relative Humidity (non-condensing)	5	95	%

Recommended Operating Conditions

Parameter	Minimum	Typical	Maximum	Unit
Case operating temperature:	0		+70	°C
Relative Humidity (non-condensing)	5		90	%

Optical Characteristics

Parameter	Minimum	Typical	Maximum	Unit
Number of Channels	8 + Common + Express (16 when using 2 filters with express connection)			
Operating Center Wavelength				
CWDM-8E-1270-1410:	1270, 1290, 1310, 1330, 1350, 1370, 1390, 1410			nm
CWDM-8E-1470-1610:	1470, 1490, 1510, 1530, 1550, 1570, 1590, 1610			nm
Channel Spacing	20			nm
Insertion Loss			2.2	dB
Express Port Insertion Loss			1.8	dB
Channel Ripple			0.3	dB
Isolation, Adjacent Channel	30			dB
Isolation, Non-Adjacent Channel	40			dB
Polarization Dependant Loss			0.2	dB
Polarization Mode Dispersion			0.2	ps
Connector	LC/UPC			
Transmitting circuit fiber	Single Mode (9/125μm) of type SMF-28e			

Norwia AS
P.O.Box 14
3201 Sandefjord
Norway

Norwia AS
Kilgata 12
3217 Sandefjord
Norway

Contact:
phone: +47 33 45 20 90
e-mail: info@norwia.no
web: norwia.com

